



www.euroncap.com

EUROPEAN NEW CAR
ASSESSMENT PROGRAMME

Technical Bulletin

Euro NCAP Mobile Progressive Deformable Barrier Face Specification

Draft Version 1.2.1

**March 2023
TB 022**

Title	Euro NCAP MPDB Specification
Version	v1.2.1
Document Number	TB 022
Author	J Ellway
Date	3 rd March 2023
Related Documents	MPDB testing protocol
Status	Information
Application Date	January 2023

Copyright ©Euro NCAP 2023 - This work is the intellectual property of Euro NCAP. Permission is granted for this material to be shared for non-commercial, educational purposes, provided that this copyright statement appears on the reproduced materials and notice is given that the copying is by permission of Euro NCAP. To disseminate otherwise or to republish requires written permission from Euro NCAP.

Preface

In 2020 the European New Car Assessment Programme (Euro NCAP) will be updating its offset frontal impact test procedure. These updates will be centred on the adoption of the Thor anthropometric test device and a new barrier face for the mobile progressive deformable barrier (MPDB). This Technical Bulletin details the specification for the honeycomb barrier face.

Euro NCAP tests may only be performed using MPDB faces from approved suppliers. The suppliers approved for use are detailed in Euro NCAP Technical Bulletin TB 029.

DISCLAIMER: Euro NCAP has taken all reasonable care to ensure that the information published in this document is accurate and reflects the technical decisions taken by the organisation. In the unlikely event that this protocol contains a typographical error or any other inaccuracy, Euro NCAP reserves the right to make corrections and determine the assessment and subsequent result of the affected requirement(s).

EUROPEAN NEW CAR ASSESSMENT PROGRAMME (Euro NCAP)

Table of Contents

1.	CHARACTERISTICS OF THE PROGRESSIVE DEFORMABLE BARRIER	6
2.	DESIGN OF THE IMPACTOR	11
3.	CONFORMITY OF PRODUCTION	14
4.	STATIC TESTS	16
5.	DYNAMIC TUBULAR IMPACTOR TEST PROCEDURE.....	17

1. CHARACTERISTICS OF THE PROGRESSIVE DEFORMABLE BARRIER

The impactor consists of three stacked aluminium honeycomb blocks. The front and rear blocks offer constant levels of force with deflection, the middle block has been processed to give a progressively increasing level of force with increasing deflection. The rear block is bonded to an aluminium back plate which is also used for mounting the impactor. The three blocks are bonded to three aluminium sheets and the entire impactor is covered by an aluminium skin (cladding) riveted to the front face.

1.1 Honeycomb blocks

1.1.1 Geometric characteristics

1.1.1.1 The impactor consists of three layers of honeycomb blocks as shown in Figure 1. The principal dimensions of all blocks are $1000 \pm 2.5\text{mm} \times 568 \pm 5.0\text{mm}$, see Figure 2. The 1000mm is in the W direction and the 568mm is in the L direction as shown in Figure 3.

1.1.1.2 The three honeycomb blocks are stacked; the rear block (A) is $90 \pm 1.0\text{mm}$ deep, the middle (B) block is $450 \pm 1.0\text{mm}$ deep and the front block (C) is $250 \pm 1.0\text{mm}$ deep.

1.1.2 Pre-crush

1.1.2.1 No part of the honeycomb is to be pre crushed.

1.1.3 Material characteristics

1.1.3.1 The expansion direction of the Aluminium Honeycomb shall be in the W direction as defined in Figure 3.

1.1.3.2 The cell dimension for the rear block shall be $6.3\text{mm} \pm 10$ per cent, the middle block shall be $9.5\text{mm} \pm 10$ per cent, the front block shall be $19.1\text{mm} \pm 10$ per cent, see Figure 4.

1.1.3.3 All honeycomb blocks must be made of 3003 aluminium.

1.1.3.4 The aluminium honeycomb blocks (A, B, C) shall be processed so that the force deflection-curve when statically crushed is within the specification and corridors in Section 4.

1.1.3.5 The processed honeycomb material used in the honeycomb blocks to be used for construction of the barrier shall be cleaned in order to remove any residue that may have been produced during the processing of the raw honeycomb material.

- 1.2 Back plate
 - 1.2.1 Geometric characteristics
 - 1.2.1.1 The geometric characteristics of the back plate (1) shall be in accordance with Figure 1, Figure 2 and Figure 5.
 - 1.2.1.2 The upper flange shall be vertical and the lower flange shall be bent through 90 degrees towards the rear.
 - 1.2.1.3 The two 30mm side flanges shall be bent through 90 degrees towards the honeycomb.
 - 1.2.2 Material characteristics
 - 1.2.2.1 The back plate shall be manufactured from aluminium of series AlMg2 to AlMg3 with hardness between 50 and 67 HBS. The back plate shall have a thickness of 3.0 ± 0.2 mm.
- 1.3 Intermediate plates
 - 1.3.1 Geometric characteristics
 - 1.3.1.1 The geometric characteristics of the two intermediate plates (2) shall be in accordance with Figure 1 and Figure 2.
 - 1.3.2 Material characteristics
 - 1.3.2.1 The intermediate plates are manufactured from 5754 H111 aluminium. The intermediate plates shall have a thickness of 0.5 ± 0.06 mm.
- 1.4 Contact plate
 - 1.4.1 Geometric characteristics
 - 1.4.1.1 The geometric characteristics of the contact plate (3) shall be in accordance with Figure 1 and Figure 2.
 - 1.4.1.2 Twenty 6.2mm holes shall be drilled through the contact plate to accommodate blind rivets.
 - 1.4.2 Material characteristics
 - 1.4.2.1 The contact plate is manufactured from 1050A H24 aluminium. The contact plate shall have a thickness of 1.5 ± 0.1 mm.
- 1.5 Cladding
 - 1.5.1 Geometric characteristics
 - 1.5.1.1 The geometric characteristics of the cladding (4) shall be in accordance with Figure 1 and Figure 2.

- 1.5.1.2 The upper flange is 75mm high, the lower flange is 53mm high before bending. The upper flange shall be vertical and the lower flange shall be bent through 90 degrees towards the rear.
- 1.5.1.3 Twenty 6.2mm holes shall be drilled through the front cladding face to accommodate blind rivets.
- 1.5.2 Material characteristics
 - 1.5.2.1 The cladding plate is manufactured from 5754 H22 aluminium. The cladding plate shall have a thickness of 0.8 ± 0.1 mm.
- 1.5.3 Rivets
 - 1.5.3.1 Twenty 6mm diameter aluminium or steel blind rivets shall be used to connect the contact and cladding plates.
- 1.6 Location of the honeycomb blocks
 - 1.6.1 The honeycomb blocks shall be aligned with each other and centred on the back plate.
- 1.7 Bonding
 - 1.7.1 Adhesive shall be applied to the surfaces as illustrated in Figure 1. The adhesive to be used throughout should be a two-part polyurethane, (such as Ciba Geigy XB5090/1 resin with XB5304 hardener) or equivalent.
 - 1.7.2 The adhesive should be applied to one surface only. In cases where honeycomb is to be bonded to aluminium sheet, the adhesive should be applied to the aluminium sheet only. A maximum of 0.5kg/m^2 shall be applied evenly over the surface, giving a maximum film thickness of 0.5mm. See Figure 1.
 - 1.7.3 Care should be taken to ensure that adhesive does not run into the honeycomb cells, causing an increase in crush strength of the honeycomb core.
 - 1.7.4 For the back plate, the minimum bonding strength shall be 0.6MPa (87psi), tested according to Section 1.7.6.
 - 1.7.5 At the bent flange connection between the cladding sheet and backplate, adhesive tape may be used in this area only to prevent bonding material from dripping during construction. No specification for this tape is given as its presence does not influence the barrier performance.

- 1.7.6 Bonding strength tests
- 1.7.7 Flatwise tensile testing is used to measure bond strength of adhesives according to ASTM C297-61.
- 1.7.8 The test piece should be 100mm x 100mm, and 15mm deep, bonded to a sample of the back plate material. The honeycomb used should be representative of that in the impactor, i.e. chemically etched to an equivalent degree as that near to the rearmost intermediate plate (2) in the barrier but without pre-crushing.
- 1.8 Construction
 - 1.8.1 The main honeycomb blocks shall be bonded to the sheets with adhesive such that the cell axes are perpendicular to the sheets.
 - 1.8.2 The outer cladding shall be bonded to the contact plate. The upper and lower surfaces of the outer cladding sheet shall not be bonded to the honeycomb blocks but should be positioned closely to it. The cladding sheet shall be adhesively bonded to the back plate at the mounting flanges.
 - 1.8.3 Holes for mounting the barrier are to be drilled in the mounting flanges and the dimensions are as shown in Figure 5.
 - 1.8.4 Five holes shall be drilled in the top flange and five in the bottom flange. The holes in the upper flange only may be opened for ease of attachment provided sufficient grip can be developed to avoid detachment during the whole impact test.
 - 1.8.5 The flange holes shall be drilled to ± 1 mm of the nominal distances as defined in Figure 5.
- 1.9 Impactor attachment
 - 1.9.1 The attachment of the barrier face shall be such that the vehicle shall not contact any part of the structure more than 75mm from the top surface of the barrier (excluding the upper flange) during any stage of the impact.
 - 1.9.2 When mounted to the trolley, the barrier backplate shall be flat, with no bends, so that there are no gaps greater than 3mm between the barrier backplate and the trolley mounting face.
 - 1.9.3 The deformable barrier shall be fixed by means of 10 bolts, five in the top mounting flange and five in the bottom. These bolts shall be of at least 8mm diameter.
 - 1.9.4 Steel clamping strips shall be used along the entire length of both the top and bottom mounting flanges. These strips shall be 60mm high and 1000mm wide and have a thickness of at least 3mm.
 - 1.9.5 The edges of the clamping strips shall be rounded-off to prevent tearing of the barrier against the strip during impact. The edge of the strip shall be located no more than 5mm above the base of the upper barrier-mounting flange, or 5mm below the top of the lower barrier-mounting flange.

- 1.9.6 Five clearance holes of 9.5mm diameter must be drilled in both strips to correspond with those in the mounting flange on the barrier. The mounting strip and barrier flange holes may be widened from 9.5mm up to a maximum of 25mm in order to accommodate differences in back-plate arrangements.
- 1.9.7 In order to accommodate the radius of the lower mounting flange, the lower edge of the trolley mounting face shall be chamfered at 45 degrees.
- 1.9.8 None of the fixtures shall fail in the impact test, both the upper and lower mounting flanges must remain attached to the trolley.

2. DESIGN OF THE IMPACTOR

All dimensions are in mm.

2.1 Barrier face

2.1.1 The tolerances on the dimensions of the blocks allow for the difficulties of measuring cut aluminium honeycomb. The tolerance on the overall dimension of the impactor is less than that for the individual blocks since the honeycomb blocks can be adjusted, with overlap if necessary, to maintain a more closely defined impact face dimension.

The MPDB is composed of the following components:

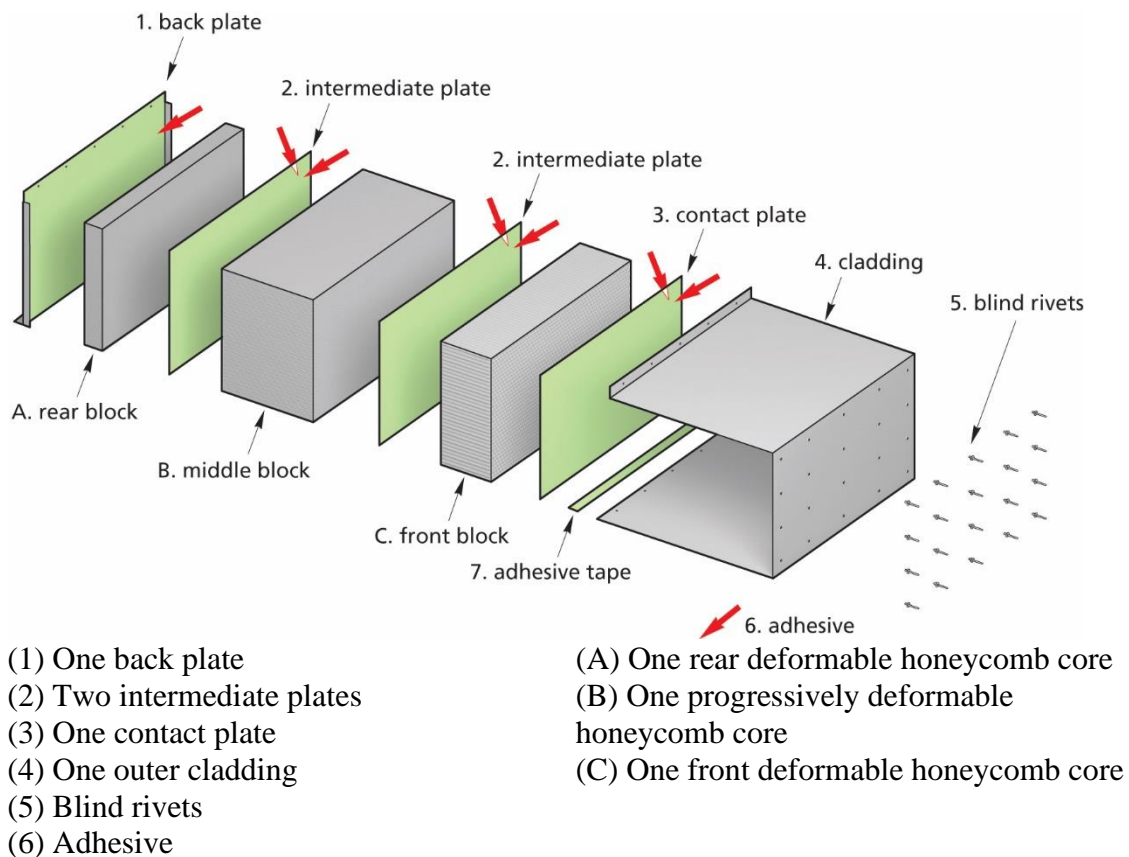

Figure 1: Exploded isometric view of MPDB

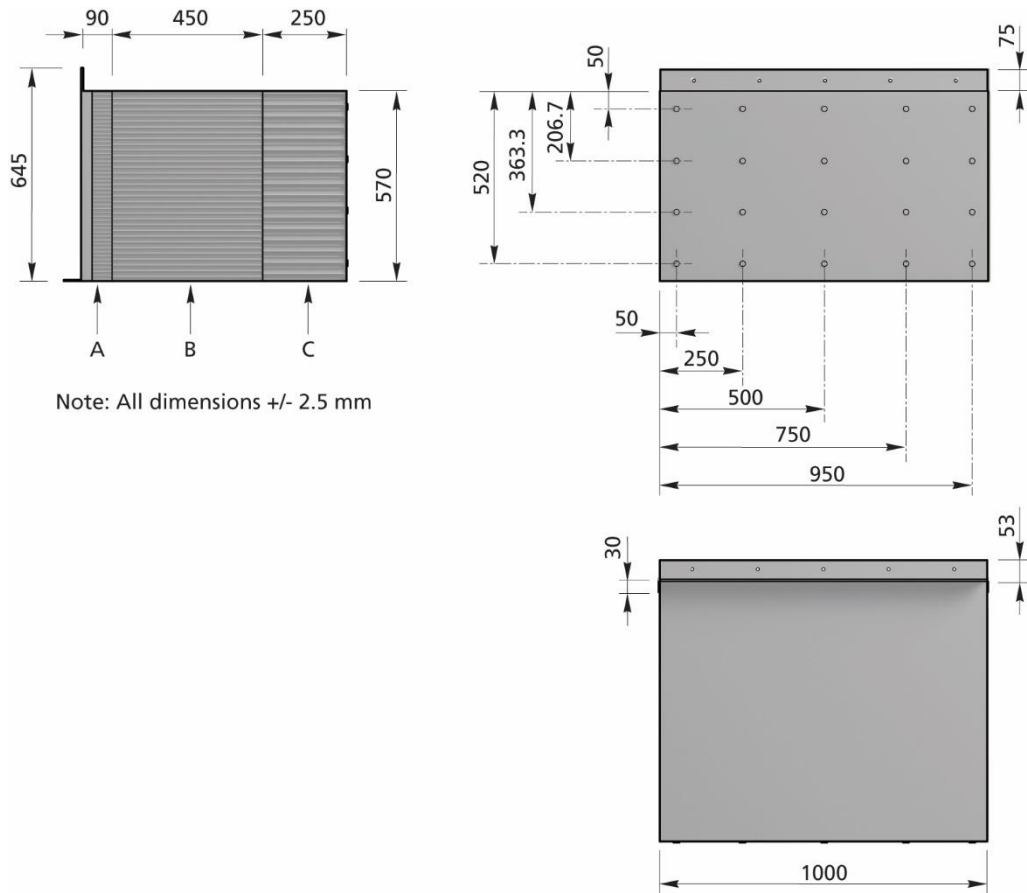

Figure 2: MPDB dimensions

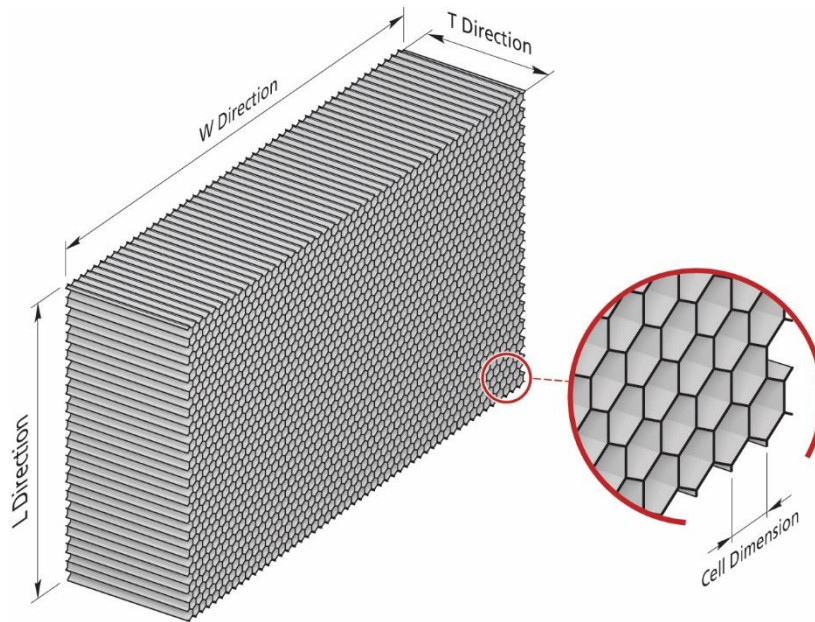
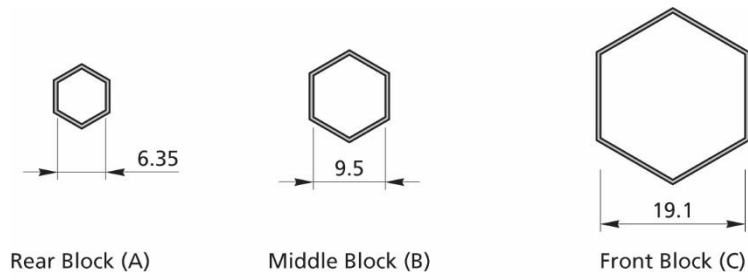

Figure 3: Aluminium Honeycomb Orientation



Note: All dimension in mm and +/- 10%

Figure 4: Dimension of Aluminium Honeycomb Cells

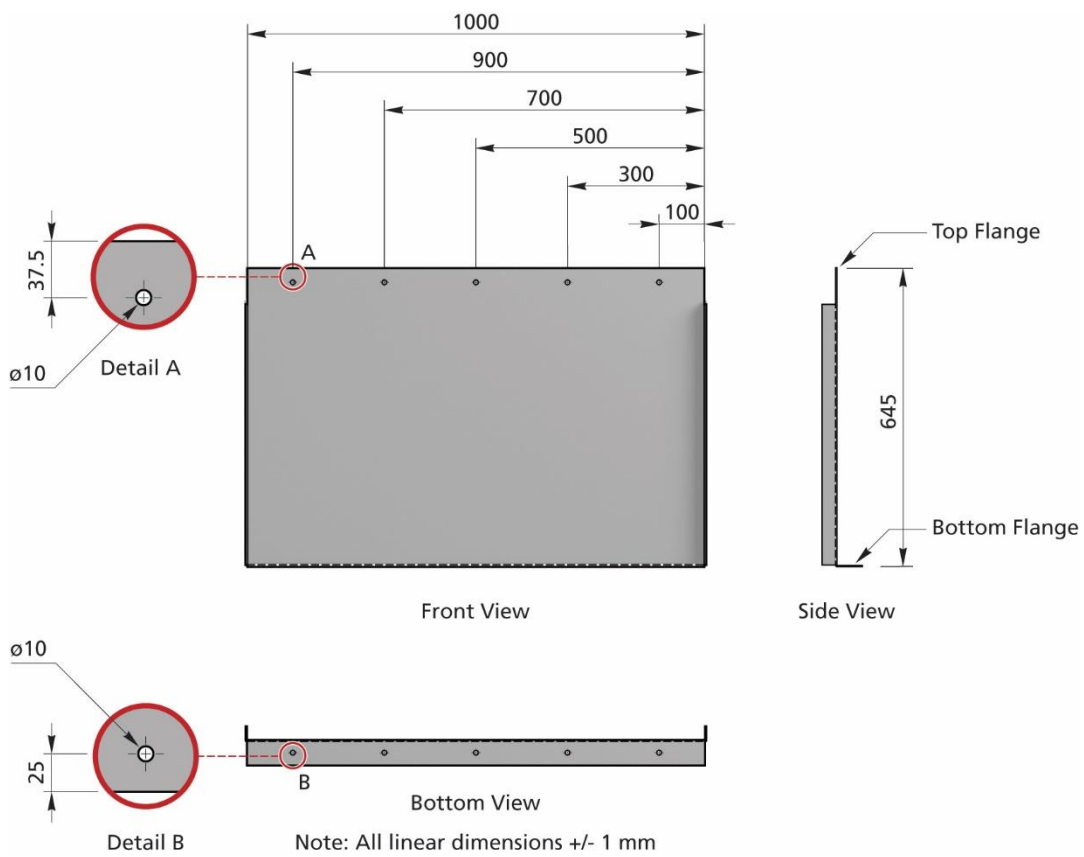

Figure 5: Top and bottom mounting flanges

3. CONFORMITY OF PRODUCTION

- 3.1 The barrier manufacturer shall be responsible for the conformity of production procedures and for that purpose must in particular:
 - 3.1.1 Ensure the existence of effective procedures so that the quality of the products can be inspected.
 - 3.1.2 Have access to the testing equipment needed to inspect the conformity of each product.
 - 3.1.3 Ensure that the test results are recorded and that the documents remain available for a time period of 10 years after testing.
 - 3.1.4 Demonstrate that the samples tested are a reliable measure of the performance of the batch (examples of sampling methods according to batch production are given below).
 - 3.1.5 Analyse results of tests in order to verify and ensure the stability of the barrier characteristics, making allowance for variations of an industrial production, such as temperature, raw materials quality, time of immersion in chemical, chemical concentration, neutralisation etc, and the control of the processed material in order to remove any residue from the processing.
 - 3.1.6 Ensure that any set of samples or test pieces giving evidence of non-conformity gives rise to a further sampling and test. All the necessary steps must be taken to restore conformity of the corresponding production.
- 3.2 The manufacturer's level of certification must be at least ISO 9001-2015 standard.
- 3.3 Minimum conditions for the control of production: the holder of an agreement will ensure the control of conformity following the methods hereunder described.
- 3.4 Examples of sampling according to batch
 - 3.4.1 If several examples of one block type are constructed from one original block of aluminium honeycomb and are all treated in the same treatment bath (parallel production), one of these examples could be chosen as the sample and care is taken to ensure that the treatment is evenly applied to all blocks. If not, it may be necessary to select more than one sample.
 - 3.4.2 If a limited number of similar blocks (say three to twenty) are treated in the same bath (serial production), then the first and last block treated in a batch, all of which are constructed from the same original block of aluminium honeycomb, should be taken as representative samples. If the first sample complies with the requirements but the last does not, it may be necessary to take further samples from earlier in the production until a sample that does comply is found. Only the blocks between these samples should be considered to be approved.
 - 3.4.3 Once experience is gained with the consistency of production control, it may be possible to combine both sampling approaches, so that more than one groups of

parallel production can be considered to be a batch provided samples from the first and last production groups comply.

3.5 Traceability

3.5.1 Barriers shall carry consecutive serial numbers which are stamped, etched or otherwise permanently attached, from which the batches for the individual blocks and the date of manufacture can be established.

4. STATIC TESTS

- 4.1 Static testing will be performed on all honeycomb blocks and follow the procedure detailed in this section.
- 4.2 Blocks A and C
- 4.2.1 The aluminium honeycomb for the homogeneous block A shall be processed so that the strength is 1.540MPa to 1.711MPa when statically crushed in accordance with the procedure defined in NHTSA TP-214D.
- 4.2.2 The aluminium honeycomb for the homogeneous block C shall be processed so that the strength is 0.308MPa to 0.342MPa when statically crushed in accordance with the procedure defined in NHTSA TP-214D.
- 4.3 Block B
- 4.3.1 One or more samples (according to the batch method) taken from each batch of processed honeycomb core shall be tested, according to the following test procedure:
- 4.3.2 The test samples shall be 250mm x 250mm x 450mm.
- 4.3.3 The samples should be compressed between two parallel loading plates which are at least 20mm larger than the block cross section;
- 4.3.4 The compression speed shall be 100 millimetres per minute, with a tolerance of 5 per cent;
- 4.3.5 The data acquisition for static compression shall be sampled at a minimum of 5Hz.
- 4.3.6 The static test shall be continued until the block compression reaches 355mm.
- 4.3.7 The crush strength characteristic for block B shall lie within the corridors in Figure 6.

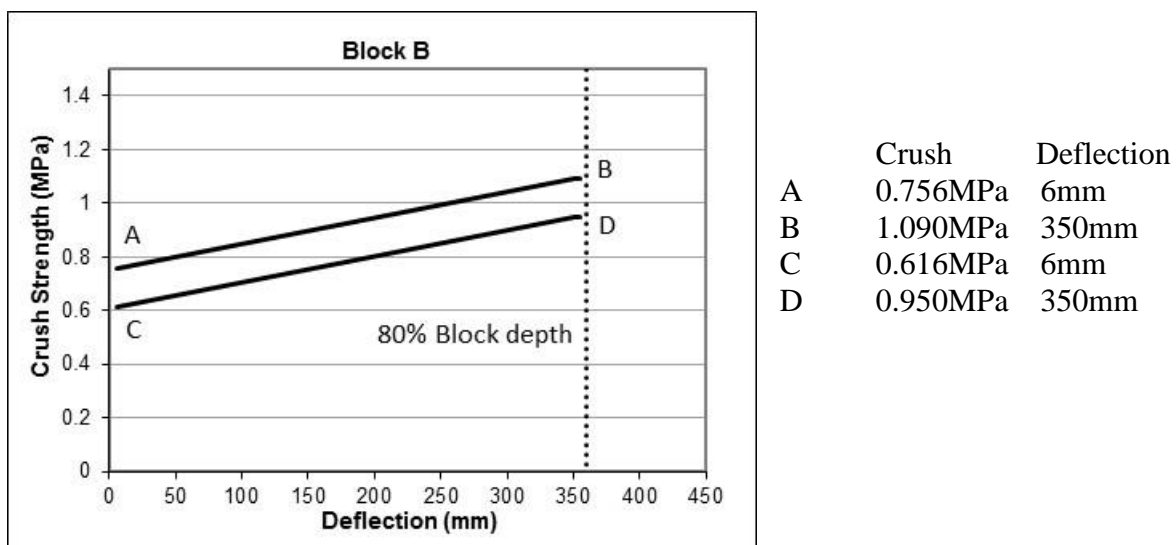

Figure 6: Block B Static Corridor

5. DYNAMIC TUBULAR IMPACTOR TEST PROCEDURE

- 5.1 Characteristics of the mobile barrier.
 - 5.1.1 The total mass shall be 1300kg +/- 20kg. The trolley shall be constructed so that no permanent deformation appears after the test. It shall be guided during the impact phase limiting the deviation to no more than 5° and 2° in the vertical and horizontal planes respectively.
 - 5.1.2 The front and rear track width of the trolley shall be 1500 ± 10mm.
 - 5.1.3 The wheelbase of the trolley shall be 3000 ± 10mm.
 - 5.1.4 The centre of gravity shall be situated in the longitudinal median vertical plane within 10mm, 1000 ± 30mm behind the front axle and 500 ± 30mm above the ground.
 - 5.1.5 The distance between the front face of the impactor and the centre of gravity of the barrier shall be 2290 ± 30mm.
 - 5.1.6 Measurements to be made on the trolley. The position of the transducers measuring the deceleration of the Centre of Gravity (COG) of the trolley during the impact shall be parallel to the longitudinal axis of the trolley (CFC of 180).
 - 5.1.7 The trolley displacement is obtained by integration of the deceleration curve of the COG of the trolley. The global crush force is obtained by the multiplication of the trolley acceleration in CFC of 60 by its mass.
- 5.2 Deformable barrier face to be tested.
 - 5.2.1 The deformable barrier to be tested shall be representative of the series production of the barrier.
 - 5.2.2 The deformable barrier shall be firmly attached to the rigid wall in such a way that no relative displacement occurs during the test. It is acceptable for the lower mounting flange to be unbent for the purpose of this test.
- 5.3 Tubular impactor design
 - 5.3.1 The impactor consists of a tubular structure as defined in Figure 7. The material of the tubular impactor must be in steel and the geometry of the impactor must be in accordance with the dimensions described. Additional strengthening and bracing may be added provided that they are in the longitudinal direction and do not alter the loading applied to the barrier.
 - 5.3.2 The tubular impactor shall be firmly attached to the trolley in such a way that no relative displacement occurs during the test.
- 5.4 Test configuration

- 5.4.1 The velocity of the trolley at the moment of impact shall be 60km/h $-0/+1$ km/h. If the test was performed at a higher impact speed and the test results meet the requirements, the test shall be considered satisfactory.
- 5.4.2 The angle between the longitudinal axis of the rigid wall and the direction of motion of the trolley shall be $0^\circ \pm 2^\circ$.
- 5.4.3 The tubular impactor shall overlap the right side of the barrier face by 800 \pm 20mm in Y axis. See Figure 8.
- 5.5 Validation
 - 5.5.1 The force deflection curves of the deformable barrier tested shall lie within the force corridors defined in Figure 9.

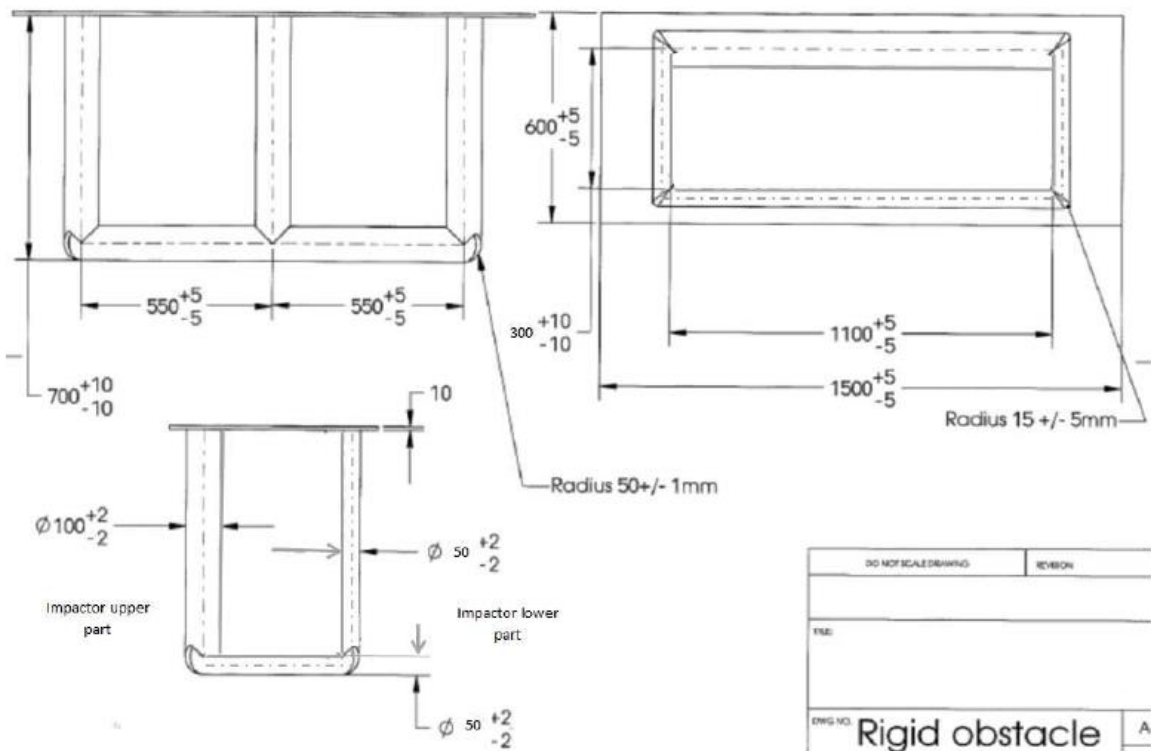

Figure 7: Tubular impactor design

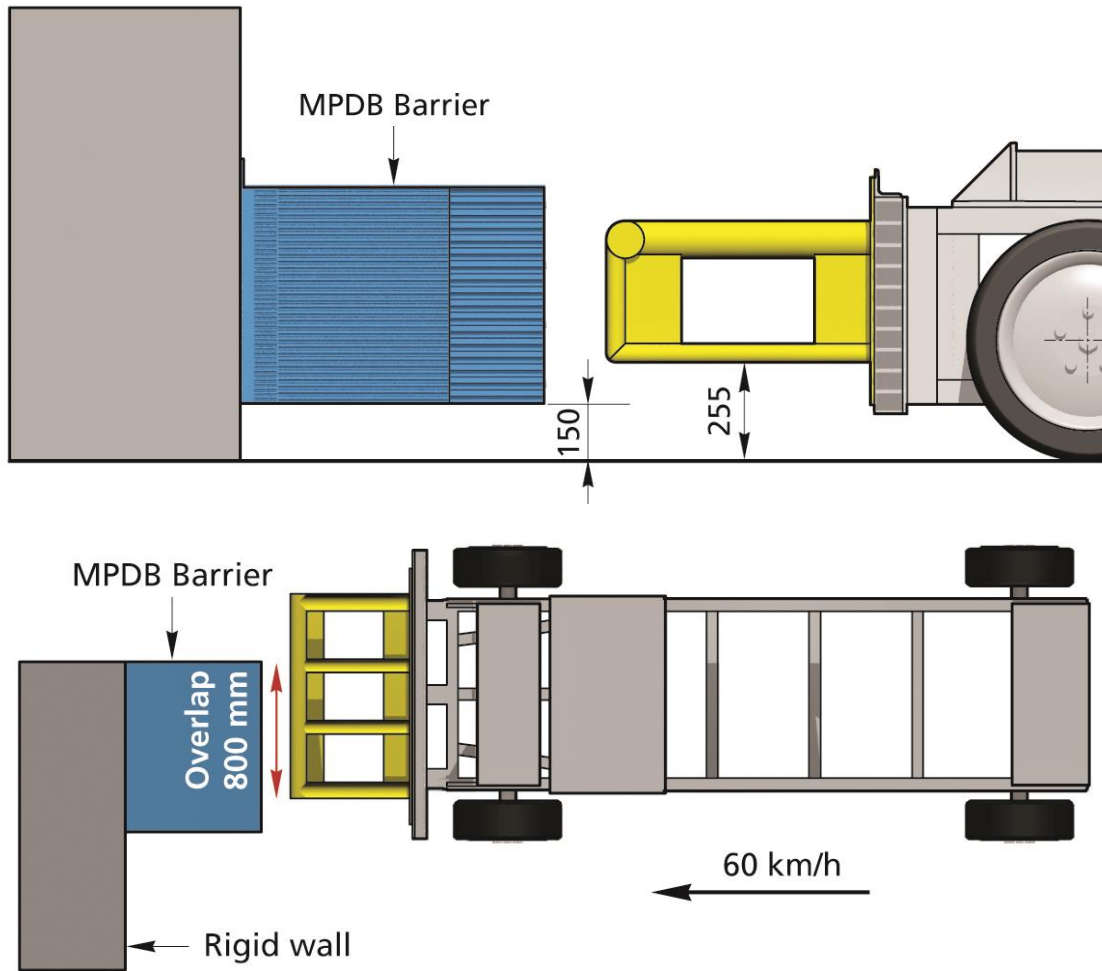
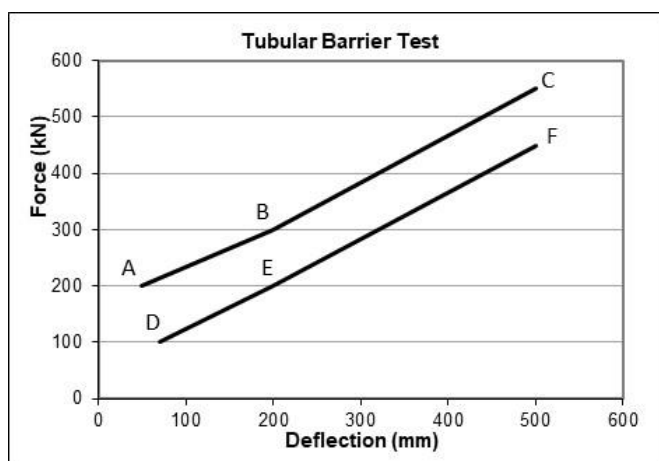

Figure 8: Impact alignment



	Force	Deflection
A	200kN	50mm
B	300kN	200mm
C	550kN	500mm
D	100kN	70mm
E	200kN	200mm
F	450kN	500mm

Figure 9: Tubular impactor corridors